

Electro-air®

ELECTRONIC AIR CLEANERS

WATER WASH ELECTRONIC AIR CLEANERS

MODELS WW-10-H/V, WW-14-H/V, WW-20-H/V

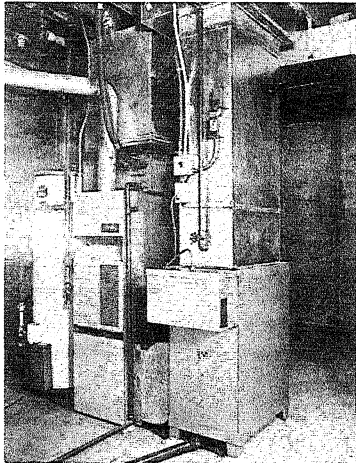

TYPICAL WATER WASH INSTALLATION—This vertical flow unit has been installed with a hand valve wash control. The cabinet is reversed for right to left airflow.

A. APPLICATION

The electronic air cleaner is a product that is designed to remove dirt, dust cooking and tobacco smoke, bacteria, pollen and other airborne contaminants from the air circulating through a forced air heating/cooling system.

The dirt particles are electrostatically charged in a collecting cell that consists of an ionizing section and a series of aluminum plates. The dirt particles cling to the plates, allowing clean air to recirculate throughout the air handling system.

Water Wash units are deluxe models specifically designed for installation in residential buildings. They feature extra-large collecting cells for increased dirt loading capacity, and a built-in water manifold that washes the cell without disassembling the unit.

Three CFM sizes are available: 1,000, 1,400 and 2,000 CFM. Each CFM size is available in both horizontal and vertical configurations, making a total of six models in the entire line.

B. MAJOR PARTS

The Water Wash unit is composed of the following components:

- 1. COLLECTING CELL**—This component consists of an ionizing section, that is constructed of tungsten wires suspended between electrodes, and a series of parallel aluminum plates. The dirt particles are electrostatically charged in the ionizing section and collected on the cell plates.
- 2. POWER PACK**—The electrical components required to furnish high voltage current for the collecting cell are housed here. The power pack consists of a transformer, two capacitors and two selenium rectifiers. An indicating light showing that power is being supplied to the air cleaner is mounted to the front. An ON/OFF rocker switch is also positioned on the front.
- 3. WATER MANIFOLD**—This deluxe feature consists of a $\frac{3}{4}$ " copper pipe, fitted with spray nozzles, that is positioned above or beside the collecting cell. The manifold is connected to a hot water supply. When the hot water is permitted to enter the manifold, it sprays the dirty collecting cell until it is flushed clean. A drain connection in the bottom of the cabinet carries away the dirty water.
- 4. CABINET**—The cabinet and power pack housing are constructed of heavy-duty, 18 gauge steel. Duct connections are easily made with the air outlet collar.

Vertical units are manufactured for airflow down and out the right side. Horizontal cabinets are shipped with airflow from left to right. The direction of airflow can be changed easily if the installation requires it.

C. PACKAGING

Water Wash units are shipped in two cartons. The larger carton contains the cabinet that is shipped with the cell, manifold and after filter in position.

The smaller carton contains the power pack, high tension lead and thru-bushing. Vertical units are shipped with legs attached. Optional legs for horizontal units can be ordered as an accessory.

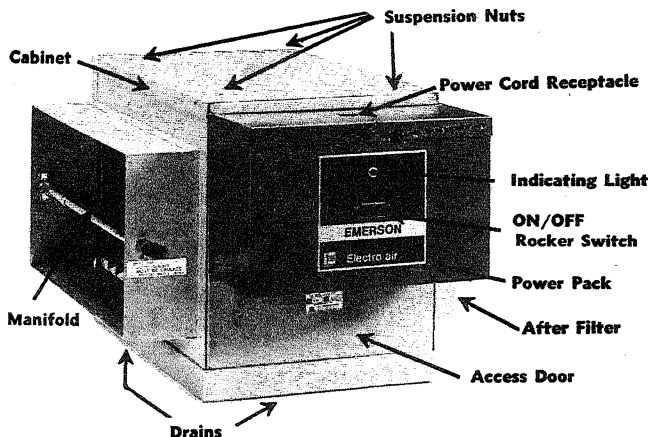
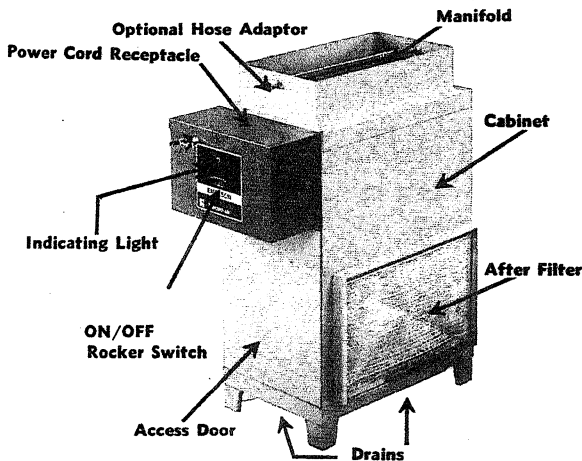

D. WASH SYSTEMS

The convenience of washing the collecting cell while it is assembled inside the electronic air cleaner, is one of the most desirable features of the product. Each water wash unit is equipped with a built-in manifold to spray the dirty collecting cell with hot water until it is flushed clean.

There are several methods of providing hot water to the manifold. Several convenience accessories to automate the process are also available.

HAND VALVE

This standard technique includes a 1/2" waterline and hand valve (stop and drain) permanently connected to the portion of the manifold protruding from the front of the electronic air cleaner. The water temperature must not exceed 140° F. since higher temperatures may cause steam to carry through the duct system. The supply should not be reduced below the 1/2" size. The valve is usually installed at the point where the manifold is soldered to the hot waterline. However, it can be placed at any accessible point in the waterline.

QUICK-CONNECT



This optional technique does not include a permanent hot waterline, thus eliminating the need for plumbing. A special Quick-Connect kit is included with each air cleaner, consisting of a 3/4" male hose adaptor, 15' of high temperature, high pressure hose with female hose connections on both ends and 15' of plastic drain hose.

The adaptor is installed by cleaning the outside of the protruding portion of manifold and the inside of the sweat end of the adaptor. Using a low temp flux and solder, solder the adaptor to the manifold.

The 15' of high temperature hose is connected from the wash manifold to any convenient hot water supply. (Faucet on hot water tank, laundry sink) The 15' of drain hose is connected to the drain in the bottom of the cabinet and unrolled to a floor drain prior to washing the cell.

The high temperature-high pressure hose should not be permanently connected to the air cleaner, as this does not permit the manifold to dry.

SPRAY-KLEAN

This optional control is designed as an electrical interlock between the power supply, air handling equipment and water supply. The control shuts off the air cleaner and the other air handling units at the same time, before the wash cycle is initiated by turning the hand valve that is inside the Spray-Klean box. Operating instructions are mounted inside the control box.

KLEAN-FLOW DETERGENT FEEDER

This optional hand operated accessory injects a limited amount of liquid detergent into the hot waterline during the washing cycle. It can only be used with the hand valve or Spray-Klean methods. Complete operating instructions are printed on the feeder bottle.

SPRAY-MATIC

This optional device completely automates the unit's washing cycle. It consists of a control box which houses a seven-day automatic time clock and wash control timing mechanism. On a specific day and hour, the Spray-Matic will turn off the air handling system's power and release hot water into the spray manifold to wash the cell. After a complete washing, it will turn the water off, permit time for the collecting cell to drip dry, turn the air handling system's blower on to force dry the collecting cell and reactivate the air handling equipment after the washing cycle has been completed. The mechanism can also be triggered manually at any time desired. A permanent drain connection must be employed with this method. Complete operating instructions are mounted inside the control box.

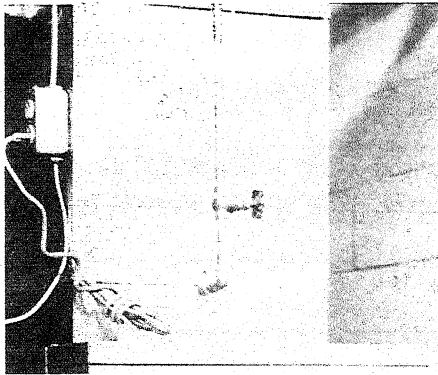

Hand valve in hot waterline connected to manifold above power pack.

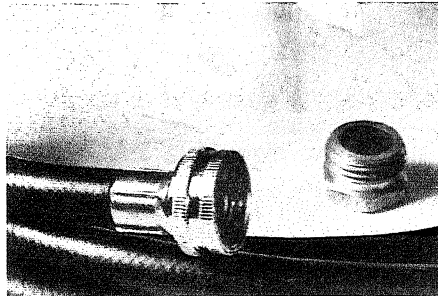

Quick-Connect kit consists of manifold hose adaptor, high temperature hose and plastic drain hose.

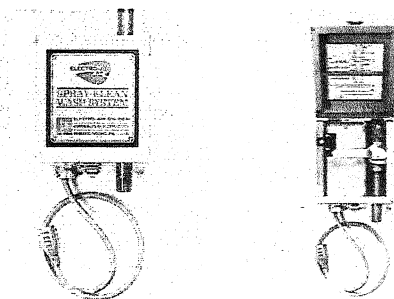

Spray-Klean electrical interlock control.

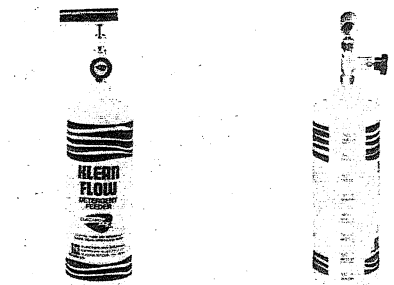

Klean-Flow accessory supplies liquid detergent.

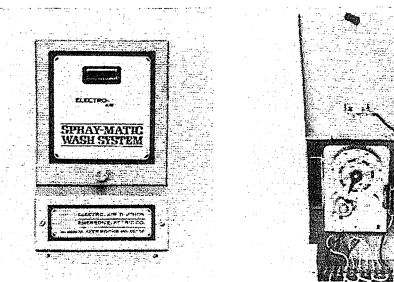

Spray-Matic control to automate wash cycle.

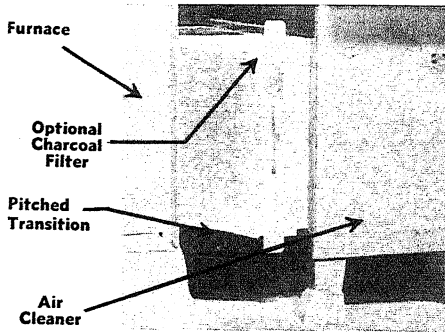

DUCT CONNECTION

The empty cabinet can now be placed in the return air duct. Make sure that the transition requirements specified under the SIZING section are followed.

PITCH DUCT WORK—Slope the bottom edges of the duct work toward the air cleaner. This permits any water accumulated in the ducts to flow back into the drain pan.

WATER LEAKS—After the air cleaner has been joined in the duct, all joints must be carefully caulked so that a tight air and water seal is assured.

The correct procedure is to put a thick bead of caulking around the air inlet collar and air leaving flange on horizontal units, and around the air leaving flange on vertical units. The transitions and duct work should be screwed directly into the caulking.

HOT WATER SUPPLY—With the cabinet permanently installed in the duct work, proceed to make the appropriate hot water connections for whatever system selected from the options listed on page 2.

Complete instructions for the Hand Valve and Quick-Connect methods are printed on page 2. Installation instructions for the Spray-Klean semi-automatic control, Spray-Matic completely automatic control, and Klean-Flow Detergent Feeder are packed with each accessory.

The following amounts of hot water, (at least 125° F, no more than 140° F) are required for at least three minutes of washing each time the cell is cleaned in place:

WW-10-H/V = 1.8 GPM

WW-14-H/V = 3.6 GPM

WW-20-H/V = 3.6 GPM

ELECTRICAL REQUIREMENTS

The only electrical requirement is a 10 amp, 105 to 125 volt, 50 to 60 cycle, ordinary single phase lighting circuit. If the air cleaner is to be installed with a Spray-Matic wash control, only 60 cycle power can be used.

Usually the supplied length of grounded 120 volt, power cord is plugged from the power pack to a nearby power receptacle that is directly wired to the air handling equipment's fan control.

The air cleaner must be grounded to prevent potential electrical shock.

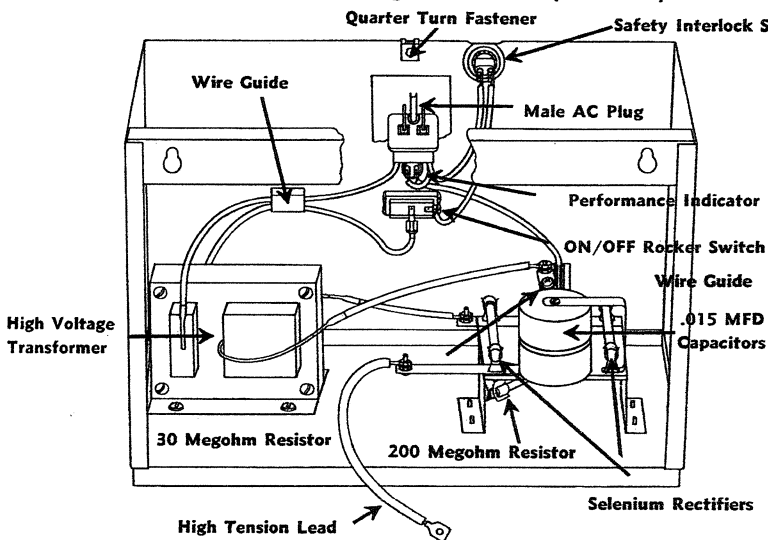

POWER PACK

The component is shipped separately in the smaller carton. It houses the primary electrical components and operating controls. It is usually mounted on the front of the electronic air cleaner. However, some installations (attic, crawl space, etc.) may necessitate the power pack being separated from the air cleaner and positioned in a remote location where it can be easily reached.

REASSEMBLE UNIT—The empty cabinet, at this time, should be positioned in the duct work with its transitions and connections caulked. Reinsert the after filter in the channel on the air leaving side. Slide the collecting cell into the cabinet so that the dirty air enters through the ionizing section (side with thin tungsten wires).

If the cabinet is a horizontal unit, the remaining access door will have holes to accommodate the ceramic thru-bushing that connects the cell to the power pack.

Access doors for vertical cabinets do not have the hole knocked out when the unit is shipped from the factory. Two 7/8" knock out discs are provided. Choose the knock out where the thru-bushing will thread into the cell and remove the knock out disc. (The knock outs are more visible from the back side of the access door where it has not been painted.)

Reinsert the access door into the cabinet.

Mounting the Power Pack to the Cabinet—The rear of the power pack housing is designed with two key hole slots that hook over round head machine screws mounted in the front of the cabinet. The cabinet door is furnished with a power pack clip. Remove the power pack lid by turning the quarter turn fastener. Insert bottom back of power pack into the clip before inserting the machine screws into the key hole slot.

After the power pack is hooked in place, fasten the two machine screws firmly securing the power pack to the cabinet. The clip prevents the power pack from being pulled away from the cabinet door.

THRU-BUSHING—The ceramic thru-bushing is screwed into the collecting cell through the 7/8" knock out previously punched through the access door. The high tension lead from inside the power pack is attached to the long threaded end of the bushing using the supplied wing nut against the crimp-on connector on the end of the high tension lead. Replace the power pack cover.

ELECTRICAL HOOK-UP—If the installation is a Hand Valve or Quick-Connect style, attach the end of the supplied, grounded 120 volt power cord to the receptacle in the top of the power pack. The other end is plugged into a grounded electrical box that is directly wired to the air handling equipment's fan control.

REMOTELy LOCATING THE POWER PACK—A special remote power pack kit is available for installations where the power pack is to be positioned in a location away from the air cleaner. The kit consists of a 15' length of high voltage wire, a glazed thru-bushing and a safety switch box with mounting bracket.

The safety box protects the protruding thru-bushing. The 15' high voltage wire is connected to the remotely located power pack.

FINAL CHECK-OUT

When the unit is totally assembled, the electrical and water connections should be checked in the following manner:

ELECTRIC—Turn the ON/OFF rocker switch ON. The indicating light on the front of the power pack should be lit, indicating that power is being supplied to the unit. If it is not, refer to the SERVICE section of this manual.

WATER—The wash cycle should be activated to determine that there are no leaks. Correct washing procedures are listed in the next section under OPERATION.

F. OPERATION

WASHING THE COLLECTING CELL

Owner maintenance of the electronic air cleaner will insure maximum filtration at all times. The most important item is to clean the collecting cell at least once a month to wash away accumulated dirt particles. One of the advantages of Water Wash units is that the cell can be washed in its installed position.

This can be accomplished by a variety of methods, depending upon the cleaning process provided.

HAND VALVE—If the installation includes a hand valve in a hot waterline leading to the manifold protruding from the front of the electronic air cleaner, the following procedures should be used:

1. Push the air cleaner's ON/OFF rocker switch to OFF.
2. Turn the air handling system's fan off.
3. Unroll the plastic drain hose, connected to the bottom of the air cleaner cabinet, to the nearest floor drain. (omit this step if a permanent drain pipe has been installed.)
4. Turn the hot water hand valve full open, and allow to run for three minutes, or until the drain water is clear. Close the hand valve.
5. Wait two minutes to allow the cell to drip partially dry and turn the air handling system's fan on. Make sure the air cleaner's ON/OFF switch is still OFF.
6. Wait an additional 45 minutes, then turn the air cleaner's ON/OFF switch ON. If a slight arcing condition (loud cracking sounds) occurs, the cell is probably not completely dry. There will be no damage to the air cleaner if the arcing is permitted to continue and it will probably cease when the cell is completely dry. If the arcing seems excessive, allow the cell to dry an additional half hour.

This picture clearly illustrates dirt particles adhering to the cell plates in an electronic-air cleaner, after two weeks of actual operation. Dirt particles, as small as 1/100 of a micron, receive an electrical charge as they enter the air cleaner's collecting cell. The charged particles cling to the cell's plates where they remain until the cell is washed during routine maintenance. →

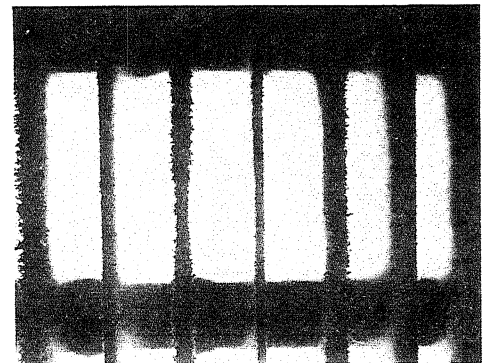

QUICK-CONNECT—The cleaning procedures are the same as listed for the hand valve procedures with the exception that the hot water supply comes from a nearby faucet (laundry sink or hot water tank.)

SPRAY-KLEAN AND SPRAY-MATIC CONTROLS—These optional controls should be used according to the instructions supplied with their separate installation manuals, or inside their control box covers.

KLEAN-FLOW DETERGENT FEEDER—The instructions on how to inject detergent into the wash cycle using this optional accessory are printed on the detergent bottle.

PERIODIC INSPECTION

Regardless of the method employed in washing the collecting cell in its installed position, the cell and after filter should be removed from the cabinet at least once a year and thoroughly washed with warm water and detergent to cleanse areas that may have been lightly cleaned by the fixed manifold.

Access to the cell is achieved by turning the power pack rocker switch to OFF, disconnecting the power cord and removing the power pack. The power pack is held in position by two machine screws that are inside the cabinet. The mounting screws and a cell thru-bushing (white ceramic tube) must be disconnected before the power pack is removed.

The air cleaner's access door is lifted up and out, revealing the collecting cell and interior cabinet. (A shipping plate holding the cell may still be in position. Remove and discard.) The cell will now easily slide from the cabinet and the after filter can be lifted from its channel.

Thoroughly clean both components, using a solution of low-sudsing dish washer detergent and warm water. Reassemble unit and continue with monthly in-place washings for another year.

